

# Medical Catalogue

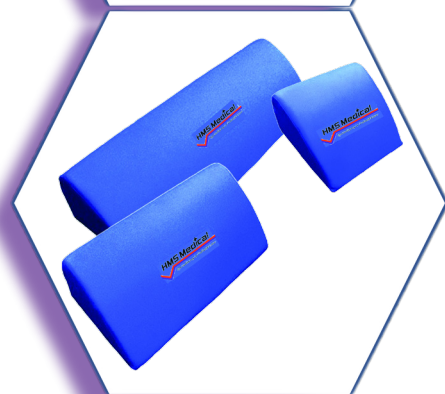

## HMS Medical

*Specialising in Patient Care*

[www.hmsmedical.com.au](http://www.hmsmedical.com.au)



# IndeeLift®

*The People Picker Upper!*

## PPU-S For Home and Care Centers

### Consumer Model

The "People Picker Upper" standing model (PPU-S) safely lifts a fallen person from the floor, eliminating the need for a call to emergency services while transforming a stressful fall into a non-event.

It can raise individuals up to 181kg to a seated or standing position, and allows for easy transfers to and from a wheelchair, bed, commode, exercise equipment or even the floor.

The standing lift function allows users to be safely raised to access a high bed or an overhead cabinet - a step stool without the step!

Can be self-operated or with the assistance of a caregiver.

Restores dignity and independence.



### Assisted Operation



### Self Operation



**Standing  
Function**



# Summary of Features

- Beveled seat-front for easy slide on transfer surface
- Wired remote for convenient operation
- Swinging/Removable Rise-Assist Handles for easy secure transfer
- Dual safety belts for added safety
- Powder coated for easy cleaning
- Small footprint for tight spaces
- Lithium-Ion battery powered with automatic charger
- 9' (2.74m) power cord

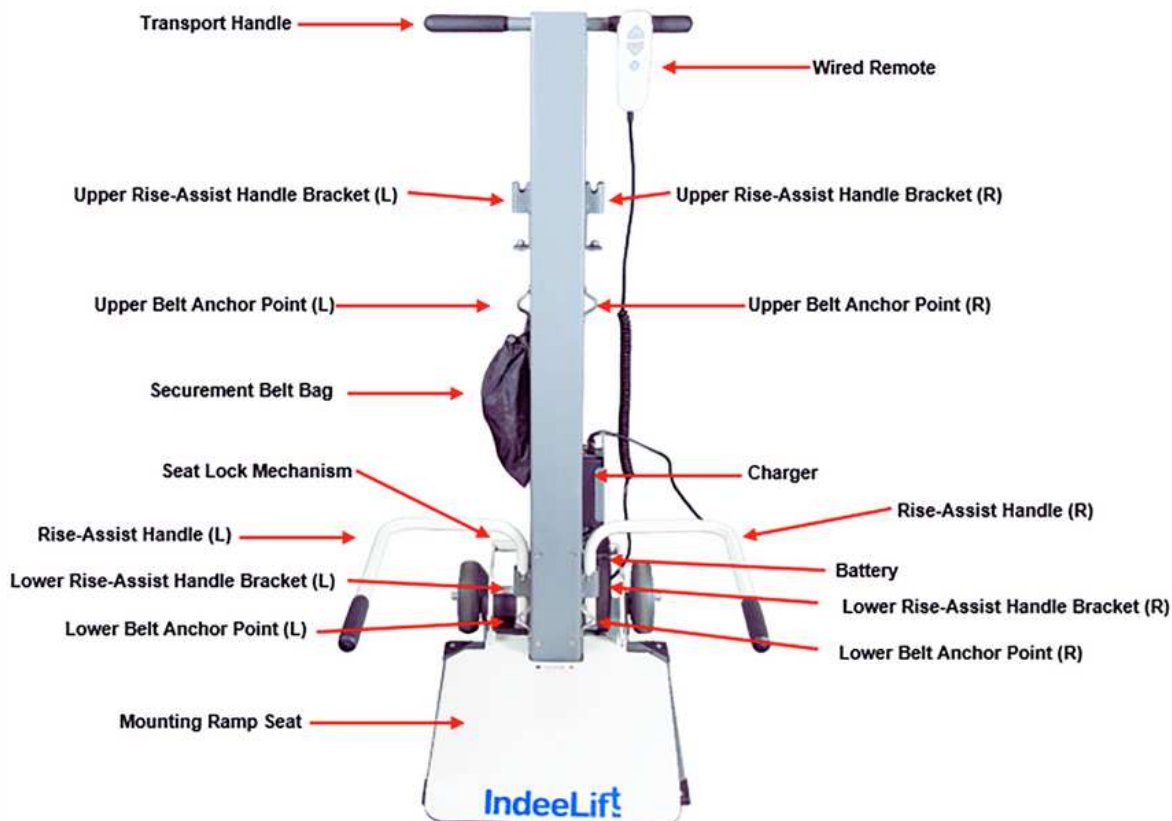

## Physical Specifications

Safe Working Load .....	181 Kg
Overall Depth .....	26.5" (67 cm)
Maximum Overall Height (raised) .....	70.75" (174 cm)
Minimum Overall Height (lowered) ...	41.75" (100 cm)
External Width incl Rise Handles.....	23" (58 cm)
Maximum Seat Height .....	30" (76 cm)
Seat Width .....	14" (35 cm)
Wheel Diameter.....	5" (13 cm)
Unit Weight .....	78 lbs. (35 kg)

## Electrical Specifications

Standard 2-prong 110 VAC Power Cord (USA)  
 Standard 2-prong 220 VAC Power Cord (International)  
 Operating Environment: >+5° C <+40° C (41° to 104°F)  
 Lithium-Ion Battery: 24 VDC

## Maintains Privacy, Dignity and Independence



T 1300 106 003  
 Dir: 07 3117 9539

E: sales@hmsmedical.com.au

www.hmsmedical.com.au

- Lateral patient transfers and patient repositioning
- Safe Working Load = 500kg
- Fits existing air supply units
- Reduces risk of cross contamination
- Eliminates costs and logistics associated with laundering
- Lowers risk of caregiver injuries
- Reduces forces required to move patient by 90%
- Radiolucent and suitable for use in X-ray and MRI
- Available in 3 sizes – 34”/39”/50”
- Coloured handles for size indicator
- Accessories and training available

### NSW CF820 State Contract Approved Products



#### Product Specifications

Description	Size	Code	Carton Quantity	CF820 Approved
Single Patient Use air-assist transfer mattress - Standard	34 inch width	RX-AM-SPU-55P	10 units	✓
Single Patient Use air-assist transfer mattress - Large	39 inch width	RX-AM-SPU-60P	10 units	✓
Single Patient Use air-assist transfer mattress - Bariatric	50 inch width	RX-AM-SPU-65P	10 units	✓



# Beasy™

Premium Transfer Boards

## Premium Transfer Systems

Our premium gliding transfer systems are made of the highest quality nylon based materials that can support up to 181kgs.



**#1100**

**BeasyTrans Original**

**101cm Long.**

**Weight: 3.4kgs.**

**SWL- 181kgs**

The #1100 can be used for any transfers where there is ample room. This board is recommended for car transfers.



**#1200**

**BeasyII**

**71cm Long.**

**Weight: 2.1kgs.**

**SWL: 181kgs**

The #1200 is great for tight spaces, shower transfers, and works well transferring to a commode.



**#1300**

**BeasyGlyder**

**81cm Long.**

**Weight: 2.3kgs.**

**SWL: 181kgs**

The #1300 can be used when the arm of the wheelchair does not come off, airplane, and car transfers. This is a very universal board.



**T: 1300 106 003**

**Direct: 07 3117 9539**

**E: sales@hmsmedical.com.au**

**www.hmsmedical.com.au**

**www.online.hmsmedical.com.au**

# Specialized Transfers

## *Automobile Transfers*

Patients can get out into the world again without stress, if they are able to transfer in and out of the car with ease. We recommend the original BeasyTrans Model #1100 for most car transfers. The Beasy Glyder #1300 model may also be used for car transfers where the wheelchair can get close to the car seat. Put the seat of the car back as far as it can go to give you more room to transfer. Sometimes transferring the patient from behind the wheelchair is more successful.

## *Supine to Supine Transfers*

***This works well for EMTs, X-ray Technicians, Hospice, Surgery of all types, Police and Fire Rescue.***

Beasy premium transfer boards can greatly assist in the supine to supine transfer, such as hospital bed to gurney. Using a draw sheet between the patient and the transfer board, roll the patient on their side. Slide the seat to one end of the board. Position the seat under the patient's buttocks on one end of the board and the other end on the destination of transfer. Using two caregivers, simply pull on the draw sheet and transfer the supine patient with a smooth, lateral slide.

## *Boosting the Patient in Bed*

Patients who require frequent boosting up, or repositioning in bed, can use the #1100 or #1200 Beasy premium transfer boards to make the process smooth, safe, and easy. Using a draw sheet between the patient and the transfer board, roll the patient onto their side. While the seat is in the middle of the #1100, or at the bottom of the #1200 (vertically positioned), position the seat under the patient's buttocks. The patient is rolled back onto the transfer board. The caregiver moves to the head of the bed, grasping the draw sheet to slide the patient higher in the bed. Place a pillow in between the patient and the bed to keep them from hitting their head on the headboard.

## *Trouble Shooting*

- ◆ If you use the board on other hard surfaces (such as a toilet seat), the board can slide. You can use a Beasy No Slip Pad, a piece of rubber (such as no slip shelf liner), or a wash rag. Wrap the no slip material around the toilet seat, or place it in between surfaces to keep the board from slipping.
- ◆ If the patient tends to glide before the seat does, you can use a Beasy No Slip Pad, or a piece of rubber (such as no slip shelf liner). Place the no slip material on the seat before transferring.
- ◆ If your board stops sliding well, you may need to lubricate your board. See below.

Beasy Transfer Boards offer a safer transition from beds to wheelchairs, wheelchairs to bath, wheelchairs to a chair, wheelchairs to the commode, and more. The Beasy Board Transfer System makes transitions easier and safer for mobility patients. Each Beasy Board is equipped with a swivel seat that offers patients more movement options. The seat spins a full 360 degrees on the base. The seat slides along the base to provide smoother transfers. Patients can reposition easily without the aid of additional caregivers. The Beasy Board Transfer System design innovation not only eliminates the arm/shoulder soreness and reduces the risk of injury but also protects caregivers' lower backs. Patients simply slide across the low-friction surface onto a safe, stable seat that easily glides from one end to the other. Unlike many other transfer board designs, patients using the Beasy Board Transfer System remain upright as they slide across.

Maintenance:

Lubricate the disc and slide. Put a light amount of spray on the top side of your transfer board, omitting the seat area. Rub in well with a soft cloth.

### Avant Clip Slings

- Two basic shapes
- Head support as standard
- Universal D-clip attachments
- Modesty loop as standard
- Durable mesh fabric
- Polyester option available
- Machine-washable to 85°C
- Non-fading woven labels
- Unique serial number
- Optional monogramming
- Compliant with AS/NZS ISO 10535:2011

### Unique attachment devices



The D-clip universal stud fixing allows for greater hoist compatibility and is suitable for use on most stud/clip fixing spreader bars. Simple click-on and click-off action giving a secure lift to both caregiver and end-user. The patented universal clip has an increased safe engagement action designed to locate safely on a variety of stud sizes.

### General Purpose Sling

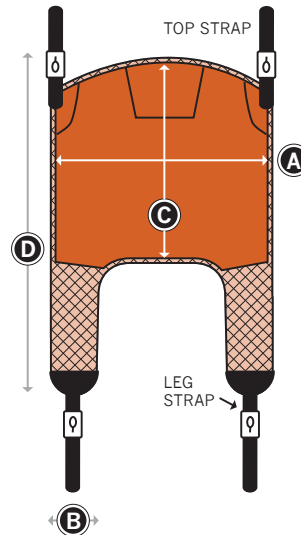

### Care Sling

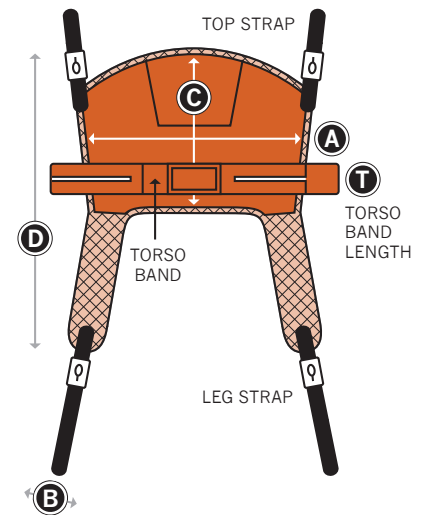

### Specifications

Avant general purpose clip sling and care clip sling have dimensions as follows – maximum SWL 320kg

#### General Purpose Sling - Clip

	Code	A	B	C	D
Extra Small	AVP02XS	72	19	58	87
Small	AVP02S	87	23	83	122
Medium	AVP02M	100	27	92	131
Large	AVP02L	108	26	101	141
Extra Large	AVP02XL	117	27	109	154
XXL	AVP02XXL	132	29	118	171

Measurements in CM

#### Care Sling - Clip

	Code	A	B	C	D	T
Extra Small	AVPC02XS	68	17	54	87	98
Small	AVPC02S	84	21	63	122	118
Medium	AVPC02M	102	22	70	124	122
Large	AVPC02L	103	22	79	136	132
Extra Large	AVPC02XL	122	22	83	143	144
XXL	AVPC02XXL	124	22	82	148	166

Measurements in CM





### Avant Loop Slings

- Two basic shapes
- Head support as standard
- Universal Safety-Slot attachments
- Modesty loop as standard
- Durable mesh fabric
- Polyester option available
- Machine-washable to 85°C
- Non-fading woven labels
- Unique serial number
- Optional monogramming
- Compliant with AS/NZS ISO 10535:2011

### General Purpose Sling

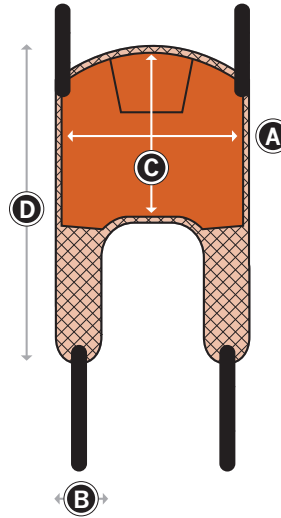

### Care Sling

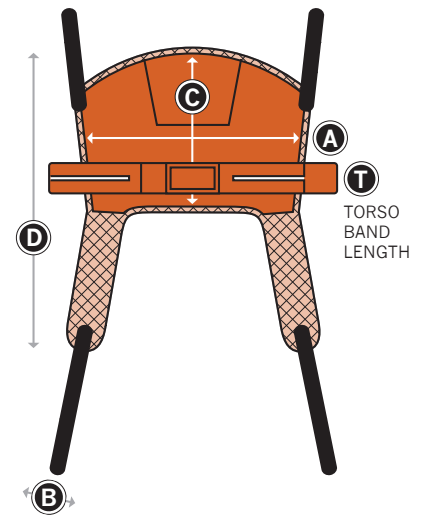

### Unique attachment devices



The Safety-Slot is the only alternative sling tape available for standard loop fitting hoists. The streamlined design improves product safety and eliminates associated loop tape fixing hazards. It is slim-line, light-weight, has high tensile strength – and is ergonomically designed to naturally slide into the most optimum position during transfer.

### Specifications

Avant general purpose loop sling and care loop sling have dimensions as follows – maximum SWL 320kg

General Purpose Sling – Loop					
	Code	A	B	C	D
Extra Small	AVGPHS02XS	82	21	75	131
Small	AVGPHS02S	82	23	78	138
Medium	AVGPHS02M	92	24	92	141
Large	AVGPHS02L	111	26	100	163
Extra Large	AVGPHS02XL	127	27	102	168
XXL	AVGPHS02XXL	136	29	105	178

Measurements in CM

Care Sling – Loop						
	Code	A	B	C	D	T
Extra Small	AVCHS02XS	68	18	54	86	97
Small	AVCHS02S	85	21	62	118	113
Medium	AVCHS02M	102	22	70	122	122
Large	AVCHS02L	102	22	79	138	132
Extra Large	AVCHS02XL	120	22	81	143	142
XXL	AVCHS02XXL	122	22	81	146	165

Measurements in CM



**Easy Applicator<sup>®</sup>**  
Technically Superior



# Easy Applicator

## Single Patient Use Slings

- With Wetness Indicator
- With Wash Indicator

### EA SINGLE PATIENT USE (SPU) SLINGS



Designed for use in:

- Hospitals
- Care Homes
- Home Care



### MATERIAL FABRIC OPTIONS

The EA SPU Slings are made with a specially developed Material Fabric.

NWME - NON WOVEN MATERIAL **EXTRA**

- Non Woven Stitch Bonded Fabric Material
- Breathable
- Cloth Type Feel
- High Wet Strength



### TWO (2) OPTIONS FOR SLING ATTACHMENT Loops and Clips

The EA SPU Slings are available with:

- Straps and Displacement Loops For Loop Fixing Spreader Bars (2, 4, 6)
- With Key Hole Opening Clips For Spreader Bars with Studs



### COMPATIBLE WITH MOST LIFTERS (HOISTS)

The EA SPU Slings are compliant with the requirements of ISO 10535



FULLBACK WITH LOOPS  
GENERAL PURPOSE SLING  
MATERIAL NWME



- Available with **Straps** and Displacement **Loops**
- Available with **Key-Hole** Opening Clips
- Available in Non Woven Material **Extra**



**REXYN**  
www.rexyn.co





**STANDARD (LOW BACK)  
WITH LOOPS  
GENERAL PURPOSE SLING  
NWME**



## EA SINGLE PATIENT USE (SPU) SLINGS



### THE EA SPU SLINGS ARE AVAILABLE IN THE FOLLOWING STYLES:

- FULLBACK - With Head Support.  
With Loops and Key-Hole Opening Clips.  
Permanently Fixed Stiffened Head Support
- STANDARD (Low Back) - Without Head Support.  
With Loops Only
- SIT 2 STAND - With Loops and Key-Hole Opening  
Clips
- REPOSITIONING - With Loops Only



### FEATURES:

- SWL Safe Working Load - 230 Kg Small (S), Medium (M)
- SWL Safe Working Load - 300 Kg Large (L), Extra Large (XL), Extra Extra Large (XXL)
- Non Reactive with commonly used Medication, Creams and Lotions
- Even Distribution and Dispersion of the Patient's Weight over the entire Sling



### Individually Identifiable and Traceable

The **uSN** (Product Unique Serial Number) on the Air Mattress provides all the information necessary about each individual product including:

- The Date of Manufacture
- Details and QC (Quality Control) of the Raw Materials utilised in the construction and manufacture of the Air Mattress
- The Operatives involved in the construction and manufacture of the Air Mattress
- The QC (Quality Control) Inspection of the finished products

**FULLBACK WITH CLIPS  
GENERAL PURPOSE SLING  
NWME**



**SIT 2 STAND WITH LOOPS  
ASSISTED STANDING SLING  
NWME**



### Features

- Single Patient Use
- Full body support including head support and padded legs
- Use for bed, chair, commode & floor transfers
- Compatible with all market leading hoists
- Available with universal clip or loop attachments
- Safe Working Load:
  - S/M/L = 230kg
  - XL/XXL = 350kg
- Tested to Australian standards AS/NZS ISO 10535:2011
- Comprehensive label includes:
  - Unique serial number
  - QR code to download user manual
  - Space for patient ID
- Wetness indicator in commode region
- 'DO NOT USE' indicator exposed by laundering or immersion
- Clear size indication via label and universal colour-coded binding
- Unique rainbow webbing clearly differentiates from washable slings
- Heavy duty stitch-bonded fabric features include:
  - patient comfort - soft polyester feels like clothing
  - breathability protects patient skin integrity
  - absorbency reduces fluid run-off
  - rip-stop nylon mesh grid for additional security
  - able to be 'spot cleaned' and spray disinfected
  - can be used in wet areas without discarding

### NSW CF820 State Contract Approved Products

#### SPU Clip Slings

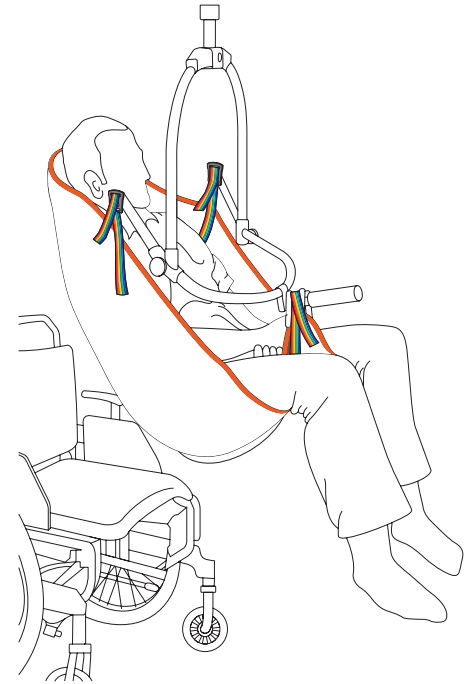
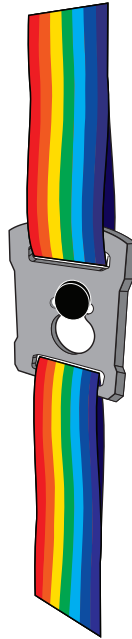

#### SPU Loop Slings

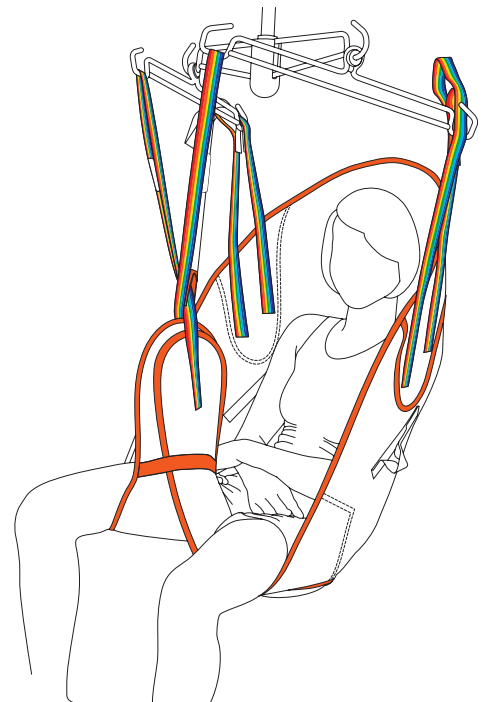
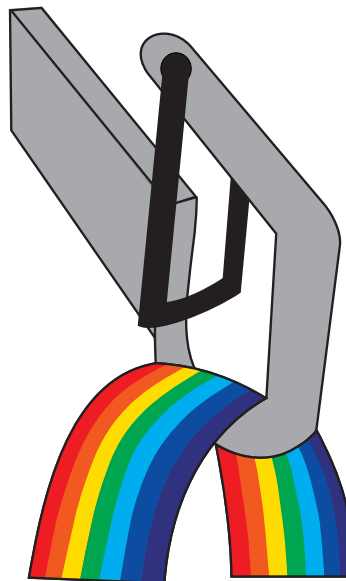

## GENERAL GUIDANCE - SLING FITTING & APPLICATION

### Sling Size Selection - Sling Dimensions

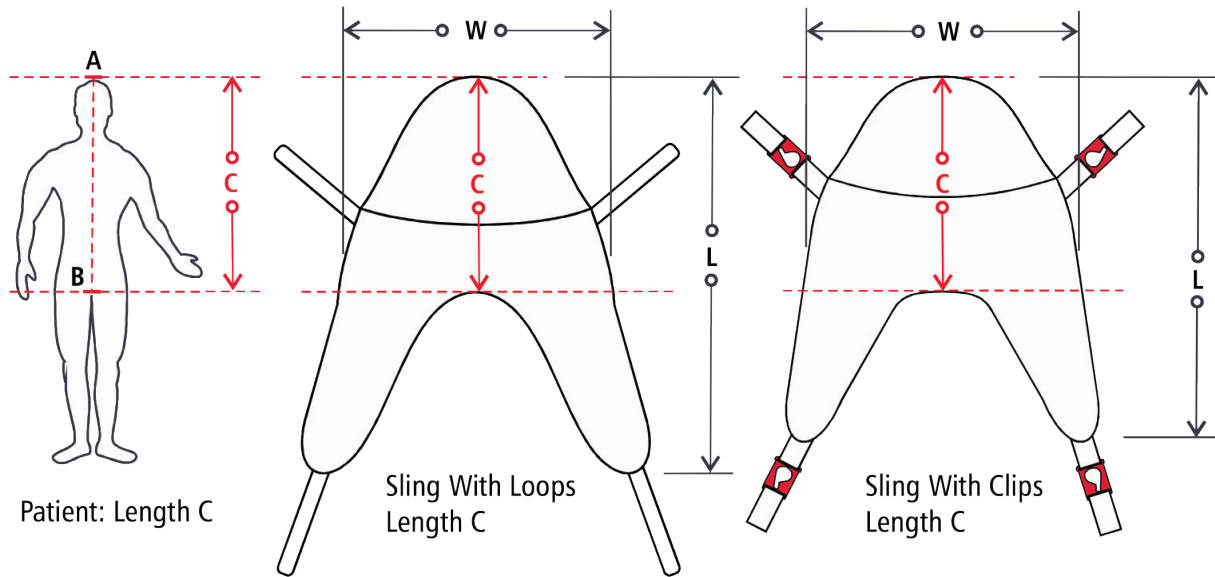

### High Back Slings With Head Support: With Loops - Dimensions in CM

Tolerance:  $\pm 5\%$

Product Code	Size	Sling Width W	Sling Length L	Sling Length C	Binding Colour	Safe Working Load	Box Quantity
RX-EASLG-10-FB-LDS-S	S	78	109	75	Red	230kg	10
RX-EASLG-10-FB-LDS-M	M	93	128	85	Yellow	230kg	10
RX-EASLG-10-FB-LDS-L	L	111	153	97	Green	230kg	10
RX-EASLG-10-FB-LDS-XL	XL	130	178	110	Blue	350kg	5
RX-EASLG-10-FB-LDS-XXL	XXL	143	204	123	Orange	350kg	5

### High Back Slings With Head Support: With Clips - Dimensions in CM

Tolerance:  $\pm 5\%$

Product Code	Size	Sling Width W	Sling Length L	Sling Length C	Binding Colour	Safe Working Load	Box Quantity
RX-EASLG-10-FB-KC2-S	S	86	116	80	Red	230kg	10
RX-EASLG-10-FB-KC2-M	M	99	133	89	Yellow	230kg	10
RX-EASLG-10-FB-KC2-L	L	113	147	102	Green	230kg	10
RX-EASLG-10-FB-KC2-XL	XL	123	173	118	Blue	350kg	5
RX-EASLG-10-FB-KC2-XXL	XXL	137	192	130	Orange	350kg	5

- Full body supportive stretcher sling
- Supine position achievable
- Creates full body stability
- Supplied with removable adjustable soft neck roll and waist support
- Boards can be removed when laundering
- Sling is manufactured in mesh
- Wash Temp 85°C/185°F
- Tumble dry low heat (max 50°C)



## Product Codes & Specifications



	100% Polyester Mesh	A	B	C	D
<b>S</b>	<b>033BS</b>	86-96cm	100-120cm	70cm	130cm
<b>M</b>	<b>033BM</b>	96-108cm	120-160cm	80cm	178cm
<b>L</b>	<b>033BL</b>	108-130cm	160-190cm	89cm	204cm

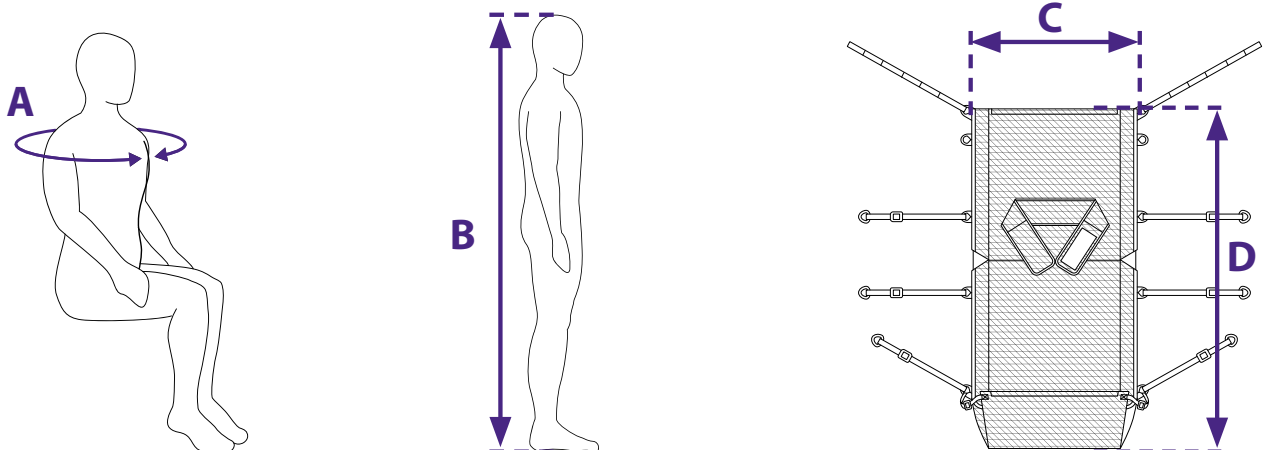

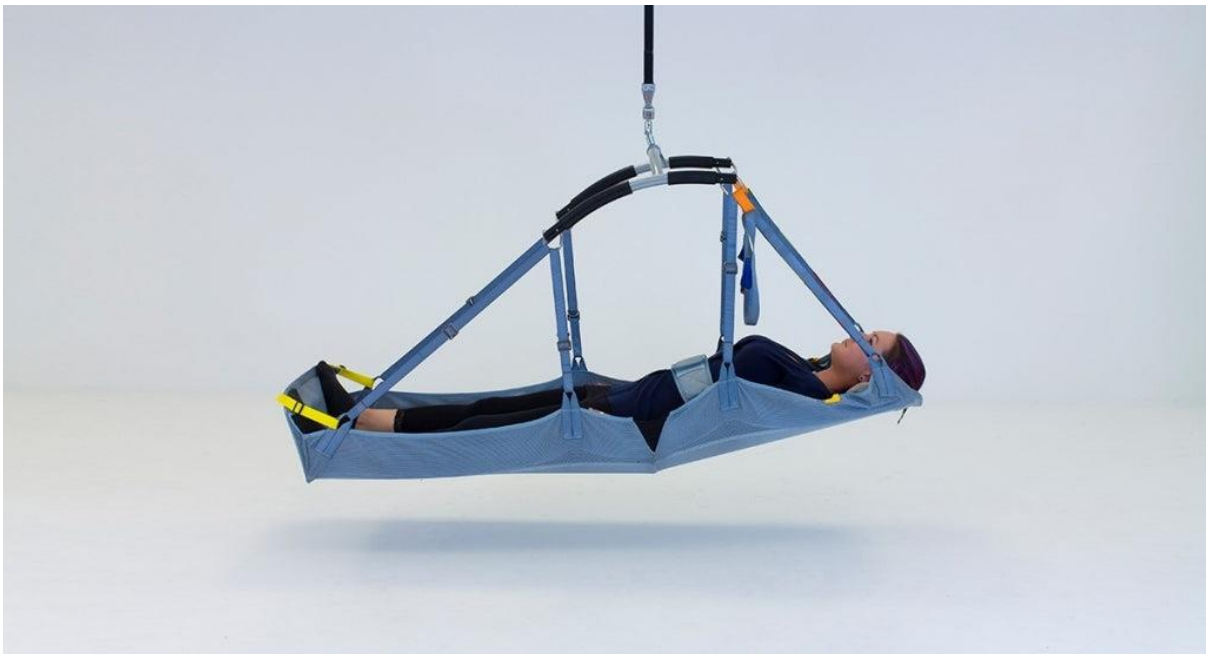

# Bariatric Wedges



**Bariatric Wedges** provide a solution when turning and positioning Bariatric Patients. They are made using high density foam with a memory foam upper to give optimal comfort but firm to support the increased weight.

- The Convex shaped surface of the wedge makes it more supportive than standard turning and positioning wedges.
- Wedges have a non-slip base to prevent them moving when in use.
- The extra firm foam supports more weight and the memory foam top layer enhances comfort and pressure redistribution.
- Covered in a Polyurethane premium barrier textile that has superior stretch and breathability properties. Is skin friendly and shear reducing.
- Waterproof
- Covering is Anti-microbial and Anti-fungal
- Fire Resistant
- Latex free
- Seams are welded and sewn for added strength and to prevent possible ingress of any fluids.
- Available in 3 sizes



**BARW9030**



**BARW6030**

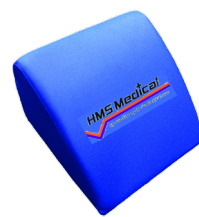

**BARW3030**

Code	Dimensions	Qty
BARW3030	30cm x 30cm x 20cm H	Each
BARW6030	60cm x 30cm x 20cm H	Each
BARW9030	90cm x 30cm x 20cm H	Each

T: 1300 106 003  
Dir: 07 3117 9539  
F: 07 3036 6625

E: [sales@hmsmedical.com.au](mailto:sales@hmsmedical.com.au)

**HMS Medical**

*Specialising in Patient Care*

[www.hmsmedical.com.au](http://www.hmsmedical.com.au)



# Patient Transfer Boards



## Lateral Folding Transfer Board

- Is beneficial for the transfer of patients who find it difficult to lie flat or suffer from breathing difficulties.
  - 150cm x 74cm
  - Anti-slip pads ensure maximum grip during transfer
  - Six ergonomically placed handholds
  - High strength polypropylene for maximum durability
  - Easily wiped clean using soap & water, disinfectants or alcohol-based solutions (up to 75%)
- CODE: BAIC-QLTS**



These boards are designed to assist in the lateral transfer of patients and are NOT intended for lifting. They should only be used to bridge a gap of 15cm max between the surfaces and therefore they do not carry a maximum safe working load limit.

## SallyBoard Transfer Boards (Slide Boards)

Lightweight for easy patient transfer.

- Constructed from lightweight, HDPE – much lighter than many transfer boards on the market
- Hanging hole at one end for tidy storage and easy accessibility
- 3 handles on each side for ease of manoeuvring
- Smooth top surface and curved edges for easy patient transfer
- 4 grip strips on underside to keep board in place
- Good level of flexibility in board where bed / barouche heights are not always at the same level
- Radiolucent – can be used for x-rays
- Large and medium size

Large :

180cm x 58cm W x 0.5cm Thick

**CODE: MT-SBL**

Medium:

150cm x 58cm W x 0.5cm Thick

**CODE: MT-SBM**

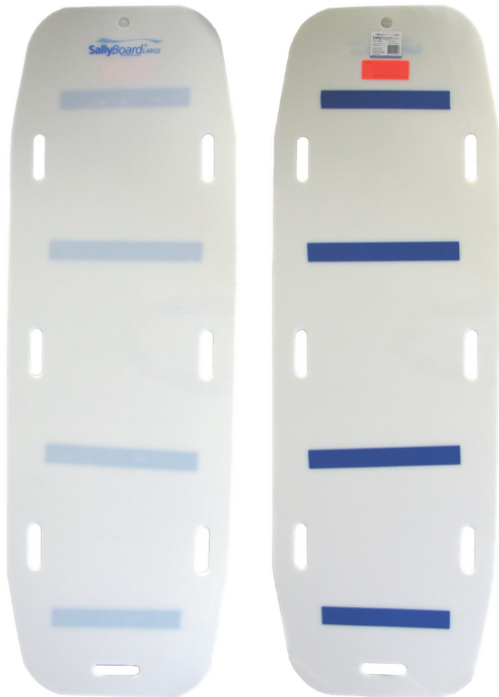

**HMS Medical**

Specialising in Patient Care

[www.hmsmedical.com.au](http://www.hmsmedical.com.au)

T: 1300 106 003

Dir: 07 3117 9539

F: 07 3036 6625

E: [sales@hmsmedical.com.au](mailto:sales@hmsmedical.com.au)

# Bariatric Gowns



- Disposable Bariatric size gowns are a comfortable and ample sizing to give dignity to the wearer.
- Longer sleeves with plastic clip closure to give easy access for procedures.
- Constructed of a blue 50gsm 3 layer SMS fabric which lightweight and breathable.
- Waist tie belt.
- Ideal for Hospitals, Day Procedure Centres, Endoscopy Units, Maternity , Radiology.
- Boxes of 50 gowns - 5 x Packs of 10eaches
- Made locally in Australia

**Qld Health Facilities:  
S4HANA #10012106**

Code	Dimensions	Box Qty
PDG3L	L120cm x W200cm	50 per Ctn

**HMS Medical**

*Specialising in Patient Care*

[www.hmsmedical.com.au](http://www.hmsmedical.com.au)

T: 1300 106 003  
Dir: 07 3117 9539  
F: 07 3036 6625

E: [sales@hmsmedical.com.au](mailto:sales@hmsmedical.com.au)

# Ergonomic Seating

## Chairs & Stools

### ERGO STOOL - with Black Base

- Fully upholstered Seat in in high grade Black Vinyl.
- Moulded seat foam for maximum comfort and durability.
- 480mm Span Black base is both compact and stable.
- 200 Stroke Gas Lift allows for excellent range of height adjustment.
- Circular ring Gas activation allows for easy access via either hand.
  - Seat Height: 520mm - 720mm
- Seat Dimension: 390mm x 90mm



**CODE: HMS ES**

### ERGO STOOL - with Aluminium Base and Strut

- Fully upholstered Seat in high grade Black Vinyl.
- Molded seat foam for maximum comfort and durability.
- 500mm Span Polished Aluminium base is both compact and stable.
- 200mm Stroke Gas Lift allows for excellent range of height adjustment.
- Circular ring Gas activation allows for easy access via either hand.
  - Seat Height: 520mm - 720mm
  - Seat Dimension: 390mm x 90mm



**CODE: HMS-ES-AL**

### PU STOOL

- Simple, functional design - easy to operate.
- Seat made from high quality polyurethane.
  - Hard wearing and easy to clean.
- 480mm Span Black base is both compact and stable.
- 160 Stroke Gas Lift allows for excellent range of height adjustment.
- Circular ring Gas activation allows for easy access with both hands.
  - Seat Height: 440mm - 580mm



**CODE: PU Stool**

### ERGO DRAFTING STOOL with Footring

- White upholstered seat in high grade vinyl.
- Moulded seat foam for maximum comfort and durability.
  - Kit comes with 16" adjustable footring.
  - 500mm span polished aluminium base.
- 270mm stroke gas lift allows for an excellent range of height adjustment.
- Circular ring gas activation allows for easy access with either hand.
  - Seat Height: 580mm - 830mm



**CODE: HMS ESTall**

**T: 1300 106 003**

**Dir: 07 3117 9539**

**F: 07 3036 6625**

**E: sales@hmsmedical.com.au**

**HMS Medical**

*Specialising in Patient Care*

**www.hmsmedical.com.au**

# Ergonomic Seating

## Chairs & Stools

### ERGO STOOL WITH BACK SUPPORT

- Upholstered in high grade white or black vinyl.
- Firm cushion seat and supportive wing back.
- Matched with 2 lever semi ergo mechanism.
- White has polished base and chrome gas lift and clear PU castors.
- Black has a black nylon base with black gas lift and twin wheel castors.

Code: HMS BES-W/B (Black Seat)

HMSWES-W/B (White Seat)



### PU STANDARD CHAIR

- Seat and Back made from High quality polyurethane.
  - Hard wearing and easy to clean.
  - 2 Lever ergo mechanisms.
- Black nylon base with black gas lift and twin wheel castors
  - Seat Height 415mm - 545mm

Code: HMS-PU-STD



### PUTALL CHAIR

- Seat and Back made from High quality polyurethane.
  - Hard wearing and easy to clean.
  - 3 Lever ergo mechanism.
- Black nylon base with black gas lift and twin wheel castors.
  - Drafting height gas lift and Footring.
  - Seat Height 580mm - 840mm.

Code: HMS-PU-Tall



**HMS Medical**

*Specialising in Patient Care*

T: 1300 106 003

Dir: 07 3117 9539

F: 07 3036 6625

E: sales@hmsmedical.com.au

[www.hmsmedical.com.au](http://www.hmsmedical.com.au)

# Ergonomic Seating

## Chairs & Stools

### SADDLE CHAIR WITH BACKREST

- Creates correct seating posture to assist with back complaints and blood flow.
  - Seat and back upholstered in high grade vinyl.
    - Adjustable backrest.
  - Matched with 3 lever fully ergo mechanism.
- Black nylon base with black gas lift and twin wheel castors.
  - Seat Height 530mm - 650mm

Code: HMS Saddle W/Back



### SADDLE STOOL

- Creates correct seating posture to assist with back complaints and blood flow.
  - Seat upholstered in high grade vinyl.
- Black nylon base with black gas lift and twin wheel castors.
  - Seat Height 530mm - 650mm

Code: HMS Saddle



### PU SIT STAND STOOL

- Seat and back made from high quality polyurethane.
  - Tilt and height adjustable.
- Black nylon base with black gas lift and twin wheel castors.
  - Seat Height 580mm - 840mm

Code: HMS PU SSS



### PU HAND HOLD STOOL

- Seat made from high quality polyurethane.
  - Convenient hand hold grip.
- 160 mm Stroke Gas Lift allows for an excellent range of height adjustment.
- Round gas lift activation ring allows height adjustment by either hand.
  - Seat Height 440mm - 590mm

Code: HMS PU HHS



**HMS Medical**<sup>SM</sup>

*Specialising in Patient Care*

T: 1300 106 003

Dir: 07 3117 9539

F: 07 3036 6625

E: sales@hmsmedical.com.au

[www.hmsmedical.com.au](http://www.hmsmedical.com.au)

# Protective Glasses



**Red / White Frames**



**Black / Black Frames**



**Orange / Black Frames**



**Large Over Glasses**



**Small Over Glasses**

Code	Dimensions
JY7AP05	Black / Black Frames
JY7AP16	Red / White Frames
JY7AP17	Orange / Black Frames
BP3017	Small over glasses
BP3187	Large Over Glasses

**HMS Medical**

Specialising in Patient Care

T: 1300 106 003  
 Dir: 07 3117 9539  
 F: 07 3036 6625

E: [sales@hmsmedical.com.au](mailto:sales@hmsmedical.com.au)

[www.hmsmedical.com.au](http://www.hmsmedical.com.au)

# SKI PAD<sup>CE</sup>

(Part of the “SKI” range of products)

The Ski Pad is designed for use in places where space is limited, such as congested hospital wards and buildings with narrow corridors or single width fire doors.

## Features:

- Durable Vinyl coated base material enables the Ski Pad to move over virtually any interior and exterior surface.
- 5cm foam pad provides protection against bumps and bruises.
- Seat belt style buckles and webbing
- Foot Pocket
- Wall mountable, wipe clean bag

## Using the SKI PAD:

- In an Emergency the Ski Pad is quickly removed from its wall mountable storage bag.
- The patient can then be transferred on to the Ski Pad (this can be performed either from bed/floor/chair).
- Place feet within the foot pocket.
- If pillows are available place these on the individuals leg and chest area (for comfort once strapped in).
- Secure the individual in place on the pad using the seat belt style cross straps.
- Using the end pulling handles the individual can be moved to a safe area. When going down stairs it is important to pull the individual feet first.

## Specifications:

Packed: 67cm x 64cm x 20cm (2 or 3 strap)

Unrolled: 197cm x 61cm

Padding: 5cm thick Weight: 5kg

Safety tested to: 160kg

Safe working load: 120kg (for two people)

## Product codes:

Two Strap: SKIP001

Three Strap: SKIP002

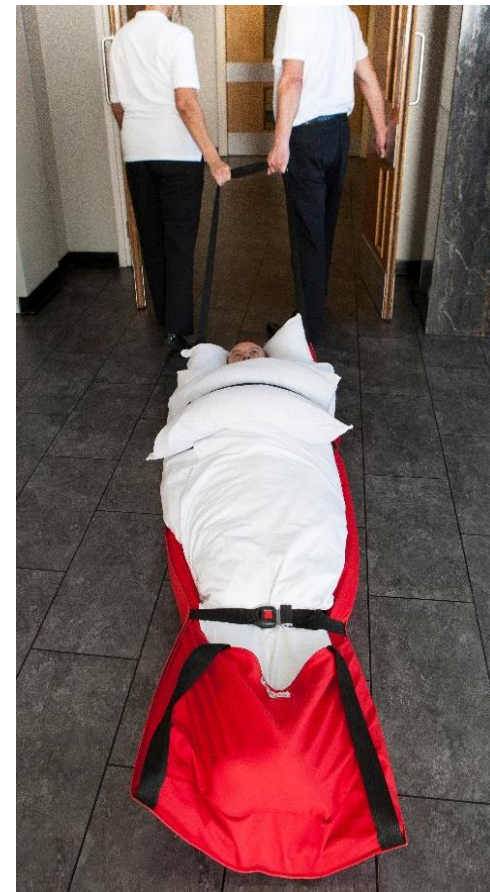

Distributor:  
**HMS Medical**  
Specialising in Patient Care

T: 1300 106 003

Dir: 07 3117 9539

F: 07 3036 6625

E: [sales@hmsmedical.com.au](mailto:sales@hmsmedical.com.au)

[www.hmsmedical.com.au](http://www.hmsmedical.com.au)



# SKI SHEET <sup>CE</sup>

(Part of the “SKI” range of products)



The SKI SHEET is designed for mattress evacuation, of non-ambulant patients, from places such as hospital wards in the event of a fire or other emergency. Permanently and unobtrusively fixed to the underside of the patient's mattress, the Ski Sheet is instantly accessible when needed

## Features

- Easy accessible pockets for the storage of the cross straps.
- Elastic corner straps for attaching securely to the underside of the mattress.
- Pulling handles at each end.
- Seat belt style metal buckles and webbing.

## Attaching the Ski Sheet:

- Simply lay the Ski Sheet on the base of the bed and place the mattress on the top.
- Concertina the belts and store within the sheets easy to access pockets.
- Attach the sheet to the mattress using the sheets elastic corner loops.
- Tuck in the end pulling handles at the head and foot end

**THERE IT STAYS - READY FOR IMMEDIATE USE!**



## Using the Ski Sheet:

- Place pillows on the patient's chest and legs for maximum patient comfort and security once secured.
- Pull the belts from the storage pockets (located next to the corner elastics).
- Fasten the buckles over the patient.
- Tighten the straps as tight as possible creating a U-shape.
- Slide the mattress off the bed.
- Move to a safe area (even down stairs) without the need for heavy lifting – let gravity do the work!



[www.spectrumhealthcare.co.uk](http://www.spectrumhealthcare.co.uk)

Email: [sales@spectrumhealthcare.co.uk](mailto:sales@spectrumhealthcare.co.uk)

Telephone: +44 (0)1793 762928

1 Kingsthorpe Business Centre, 63 Studland Road, Kingsthorpe, Northampton, NN2 6NE, UK.  
Spectrum Healthcare (UK) Ltd - Registered in England No. 06197553







## Laundering Instructions

**MACHINE WASHABLE**

**DO NOT BLEACH**

**DRIP DRY or TUMBLE DRY ON A LOW HEAT**

**Washing:** When laundering does become necessary the buckles on the belts should be fastened, and a temperature of up to 80°C can be used.

To protect the buckles it is recommended that the sheets should be washed in a bag.

Thorough rinsing will ensure that no detergent deposit is left.

A disinfectant may be added to the final rinse if required.

**Drying:** A low temperature is recommended to prevent the nylon material from becoming brittle and shrinking.



Modified  
SKI Sheet



### Specifications:

**Packed: 27cm x 10cm x 13cm**

**Unrolled: 196cm x 85cm**

**Safety tested to: 240kg**

**Safe working load: 120kg – for two people**

**Material: Nylon**

**Weight: 1kg**

### Product codes:

**SKISH01 (Standard)**

**SKISH02 (modified with a positioning handle situated at each pocket – As picture)**

Distributed By:



**T: 1300 106 003**

**Dir: 07 3117 9539**

**F: 07 3036 6625**

**info@hmsmedical.com.au**

**www.hmsmedical.com.au**

# The Clever Folding Cart



# CLAX

The clever Clax Cart design is the only 2 tier complete folding trolley that folds flat for ease of storage. The Clax Cart has an ergonomic handle with a simple push button that provides the effortless folding function. It also has a number of great design features including a wheel brake mechanism, one collapsible crate and a lift up tray. 24 month warranty.

Specifications	
<b>Total Capacity</b>	60kgs - Top 20kgs / Bottom 40kgs
<b>Unit Weight</b>	7kgs
<b>Dimensions Assembled</b>	890mm x 550mm x 1030mm
<b>Dimensions Folded</b>	670mm x 470mm x 110mm



Adding an extra Basket makes makes the CLAX very functional for your facility



Made in Germany

Code	Description
HMCT-1	Clax Cart (comes with 1 basket)
HMCT-2	Clax Cart with 2 baskets
Clax Basket	Extra Clax Basket

## HMS Medical

Specialising in Patient Care

T: 1300 106 003  
Dir: 07 3117 9539  
F: 07 3036 6625

E: sales@hmsmedical.com.au

[www.hmsmedical.com.au](http://www.hmsmedical.com.au)

# X-Cart Folding Trolley



The X-Cart is a collapsible folding trolley that has many applications

- Collapses easily for storage / transport with the click of a button on the handle.
- Wheels can also be removed easily for more compact storage / transportation.
- Comes supplied with one basket.
- Foot pedal brake to lock cart in position when loading and unloading.
- Moulded plastic and aluminium design means the X-Cart is lightweight but robust.
- Excellent carrying capacity.
- The basket fits and holds foolscap suspension files.
- Top platform folds back to give greater carrying capacity using the bottom platform.

The X-Cart fits foolscap suspension files

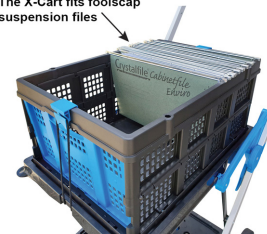

## Assembled Dimensions

- Overall Length: 1000mm
- Overall Width: 600mm
- Overall Height: 1070mm

## Folded Dimensions

- Overall Length: 740mm
- Overall Width: 540mm
- Overall Height: 105mm

## Basket Dimensions (External)

- Overall Length: 560mm
- Overall Width: 400mm
- Overall Height: 260mm

## Specifications

- Total trolley capacity: 90kgs
- Capacity - Top platform: 40kgs
- Capacity - Bottom platform: 50kgs
- Trolley Weight: 10kgs
- Basket weight: 1.8kgs
- Total height using one basket; 830mm

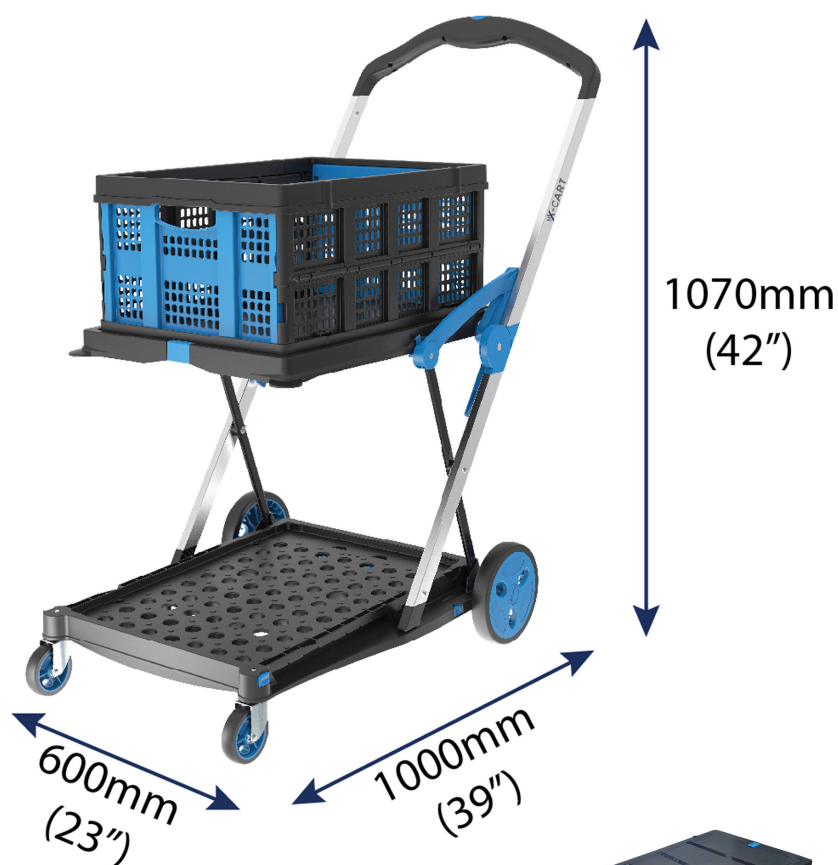

## Trolley with one basket - CODE:TR1800

### Optional Extras

- Extra Baskets - TR1805
- Lid for basket - TR1806
- Vinyl cover - TR1810
- Tool Bin - TR1815



Tool bin clips onto the X-Cart frame and is supplied with 2 removable dividers



Lid to suit X-Cart Basket

**HMS Medical**

Specialising in Patient Care

[www.hmsmedical.com.au](http://www.hmsmedical.com.au)

T: 1300 106 003

Dir: 07 3117 9539

F: 07 3036 6625

E: [sales@hmsmedical.com.au](mailto:sales@hmsmedical.com.au)



# SYST'AM® P913L / OCCIPITAL SYSTEM

PREVENTION AND POSITIONING OF THE OCCIPITAL AREA

## MATERIALS

80  
kg/m<sup>3</sup>



Visco foam



Removable  
POLYMAILLE®  
integral cover

NF EN ISO 597 - 1 & 2

### Foam maintenance:



### Cleaning POLYMAILLE® cover:



## INDICATIONS

- Prevention and positioning of the occipital area.

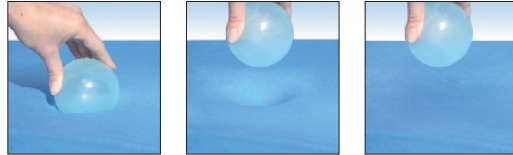

### VISCOELASTIC FOAM WITH SHAPE MEMORY

- Defined body moulding and increased body surface area in contact with the foam.
- More effective distribution of pressure: reduction of transcutaneous pressure on highrisk zones, facilitated blood flow.
- Increased comfort and more effective maintenance of patient position.

## AVAILABLE VERSIONS



SYST'AM® P913L /  
OCCIPITAL SYSTEM

## FEATURES OF THE COVERS

### FABRIC COATED WITH BI-STRETCH POLYURETHANE

- Reduces friction and shear effects.
- Supple and soft to the touch (comfortable).
- Favours the exchange of gases (steam, sweat):
  - fights against maceration.
- Impermeable material:
  - better hygiene,
  - longer support system lifespan.
- Washable at 90°C, can be decontaminated using cold sprays.
- Treated to resist fire.
- In multi-patient use, it is preferable to buy one new cover per patient.



DESIGNATION	ITEM CODE	SIZE L x W x H (cm / inches)
Occipital system	P913L1HW	50 x 43 x 9,5 cm / 19,7 x 16,9 x 3,7"



## Medical Cushions

## Medical Cushions

HMS Medical has a cushion suitable for people on all levels of the pressure ulcer risk scale. We aim to provide solutions to the pain and discomfort caused by pressure sores and pressure ulcers on the skin of people who have limited mobility.

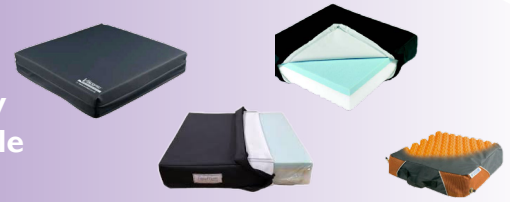

**The Polyair®** range of medical cushions are for patients with any level of risk and for people who already have pressure ulcers.

The Polyair cushion has an electronic pressure measuring device, included, that enables the lay person to set it up because the gauge is scientific thus removing arbitrary and often incorrect set up - no longer necessary to use your hand as a gauge. Polyair cushion valves are all non-leak, meaning that if the pump is not attached, the valve will not leak the air from the cushion.

<b>POLYAIR® 60 P301CM - 6cm / Single valve</b>		<b>Weight Range</b>
P301CM40401HW	40cm x 40cm / 16 x 16"	30 - 80kgs
P301CM46461HW	46cm x 46cm / 18 x 18"	40 - 140kgs
<b>POLYAIR® 100 P302CM - 10cm / Single valve</b>		
P302CM40401HW	40cm x 40cm / 16 x 16"	40 - 80kgs
P302CM46461HW	46cm x 46cm / 18 x 18"	40 - 140kgs



<b>POLYAIR® 60 P301C - 6cm / Dual valve</b>		<b>Weight Range</b>
P301C40401HW	40cm x 40cm / 16 x 16"	40 - 80kgs
P301C40461HW	40cm x 46cm / 16 x 18"	40 - 120kgs
P301C46401HW	46cm x 40cm / 18 x 16"	40 - 120kgs
P301C46461HW	46cm x 46cm / 18 x 18"	40 - 140kgs
P301C51461HW	51cm x 46cm / 20 x 18"	40 - 160kgs
P301C51501HW	51cm x 50cm / 20 x 20"	40 - 180kgs



<b>POLYAIR® 100 P302C - 10cm / Dual valve</b>		
P302C40401HW	40cm x 40cm / 16 x 16"	40 - 80kgs
P302C40461HW	40cm x 46cm / 16 x 18"	40 - 120kgs
P302C46401HW	46cm x 40cm / 18 x 16"	40 - 120kgs
P302C46461HW	46cm x 46cm / 18 x 18"	40 - 140kgs
P302C51461HW	51cm x 46cm / 20 x 18"	40 - 160kgs
P302C51501HW	51cm x 50cm / 20 x 20"	40 - 180kgs



<b>POLYAIR® 60 P301XL - 6cm / Dual valve</b>		<b>Weight Range</b>
P301C56461HW	56cm x 46cm / 22 x 18"	40 - 230kgs
P301C61501HW	61cm x 56cm / 24 x 22"	40 - 270kgs
<b>POLYAIR® 100 P302CXL - 10cm / Dual valve</b>		
P302C56461HW	56cm x 46cm / 22 x 18"	40 - 230kgs
P302C61561HW	61cm x 56cm / 24 x 22"	40 - 270kgs

**System® VISCOFLEX® Cushion** is anatomically molded, features memory effect and is crafted from high quality viscoelastic foam. The foam is designed to adapt gently and accurately with the seating area contour, which results in enhanced stability. Together with its foam mechanical elements and its anatomic shape, the viscoelastic foam significantly increases the contact area with the cushion, which results in reduced transcutaneous pressure hence improving overall comfort, stability and comfort. Designed specifically to prevent pressure sores, Viscoflex® offers unmatched resistance and is a class leading industrial grade foam that prevents the effects of punching.

**Designed for use by those assessed as moderate to high risk of pressure injury.**

P361C with POLYMAILLE cover

36 x 36 x 8cm - 50kgs

42 x 42 x 8cm - 100kgs

42 x 46 x 8cm - 110kgs

45 x 42 x 8cm - 110kgs

45 x 46 x 8cm - 130kgs

51 x 46 x 8cm - 150kgs

51 x 50 x 8cm - 160kgs



**System® VISCOFLEX®+ Cushion** is a highly effective cushion constructed from viscoelastic memory foam. Suitable for patients with low levels of mobility, it has excellent pressure relieving qualities which makes it suitable for patients at a high to very high risk of pressure sore development. This cushion's anatomically shaped design improves positioning, stability and comfort and also increases the contact area of the cushion with the user's body.

In addition to all the features of the System Viscoflex Pressure Relief Cushion, this cushion also includes an internal skeleton of high-capacity weight-bearing foam. This structures the cushion and optimises weight distribution.

*There is an anti-punching foam insert (A) that is specifically positioned in relation to the ischia (B). This distributes the pressure to the buttock peripheral zone, which stabilises and supports the pelvis and prevents it from reaching the bottoming zone.*

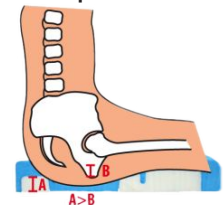

*The pre-ischial ridge of the cushion sits beneath the back of the legs, preventing forward sliding and maintaining a proper spinal position. The prevention of sliding bolsters stability, ensuring reliable and consistent positioning.*

**Designed for use by those assessed as high to very high risk of pressure injury.**

P361CA with POLYMAILLE cover

36 x 36 x 8cm - 70kgs

42 x 42 x 8cm - 110kgs

42 x 46 x 8cm - 120kgs

45 x 42 x 8cm - 120kgs

45 x 46 x 8cm - 130kgs

51 x 46 x 8cm - 150kgs

51 x 50 x 8cm - 160kgs

Custom sizes available: 42 x 50 / 45 x 50 / 56 x 46 / 61 x 50

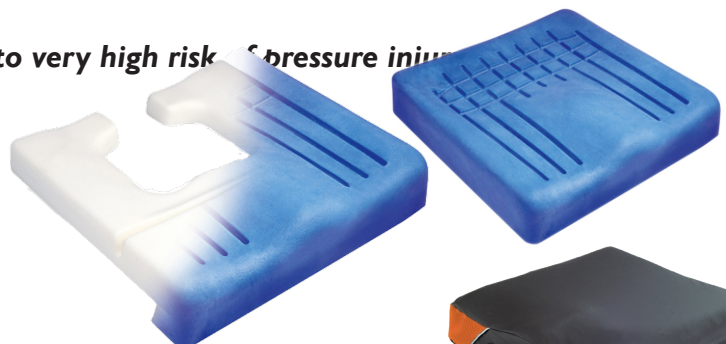

**System® VISCOFLEX®+ With Pommel** combines the features and benefits of the VISCOFLEX®+ with an innovative stabilising pommel, that is adjustable and completely separate from the cushion. The System® stabilising pommel has its own cover attached on the cushion. This simplifies the setting and adjusting of the equipment and the transferring to and from the chair.

The Pommel provides a better seating position - prevention of the forward sliding and falls without the need for restraints / seatbelts



Forward sliding in the sitting position is a very frequent postural deficit in geriatrics and attributes to the major risk factor of sacro-coccygeal pressure sores. Forward sliding stabilised by a pelvic pommel thus blocks the pelvis on the sagittal plane. The Pommel allows precise adjustment to all patient morphologies easily and respects the natural curves and opening of the lower limbs.

*The System® VISCOFLEX®+ With Pommel posture support cushion provides a solution to forward sliding while promoting patient safety and preserving their dignity.*

**Designed for people at risk of forward sliding and at a high to very high risk of pressure injury**

- P361CP with POLYMAILLE cover
- 42 x 42 x 8cm - 100kgs
- 45 x 42 x 8cm - 110kgs
- 45 x 46 x 8cm - 130kgs



**System® VISCOFLEX® Air Cushion** is an adjustable anatomically molded viscoelastic foam cushion with an air cells insert. The efficiency of the air cells technology combined with the comfort of the viscoelastic foam with memory effect, optimizes the pressure distribution according to patient's morphology and therewith it enables a customized immersion for an effective pressure sore prevention. The very high density viscoelastic foam with memory effect offers a precise moulding of the body and improves the patient's comfort and stability with an anti-bottoming layer. The simple and easy customized inflating is achieved with the included single-handed inflating pump.

**Designed for use by those assessed as high to very high risk of pressure injury.**

- P361CR with POLYMAILLE cover
- 42 x 42 x 8cm - 110kgs
- 45 x 42 x 8cm - 120kgs
- 45 x 46 x 8cm - 140kgs

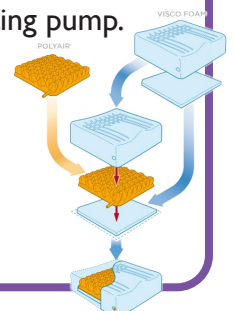

**System® POLYMAILLE covers** are a hypoallergenic polyurethane cover that have an antibacterial, anti-germ and anti-fungal coating. Has a two-way stretch to ensure comfort for the user and reduce shear forces. They features a zip that covers 3 sides and a non-slip base.

Distributor:

**HMS Medical**

Specialising in Patient Care

T: 1300 106 003

D: 07 3117 9539

E: info@hmsmedical.com.au

**Genteel**<sup>®</sup>  
the gentle vacuum blood draw device



# A LANCING DEVICE LIKE NO OTHER

## Give fingers a break when checking blood sugar.

Genteel<sup>®</sup> helps to remove the obstacles for those with Type 1 or Type 2 diabetes, young or old, that prevent prescribed blood glucose testing.

**Mission:** Provide the most comfortable, pain-free, innovative lancing devices and lancets for the healthcare marketplace

**Vision:** Become the market leader for lancing devices and lancets used for the retrieval of blood used for monitoring, calibration and testing

### PAIN FREE

Eliminates severe puncture marks, swelling, bruising and numbness

### CHECK MORE OFTEN

Removes the obstacles of pain and trauma so people can start checking blood sugar levels as doctors prescribe

### STOP SQUEEZING

With its vacuum, Genteel<sup>®</sup> brings blood to the surface and forms the perfect drop. Re-poking and squeezing is a thing of the past

### TEST ANYWHERE

Gives fingers a break using vacuum and depth control. Palms match fingers!



800-00013B

[www.online.hmsmedical.com.au](http://www.online.hmsmedical.com.au)



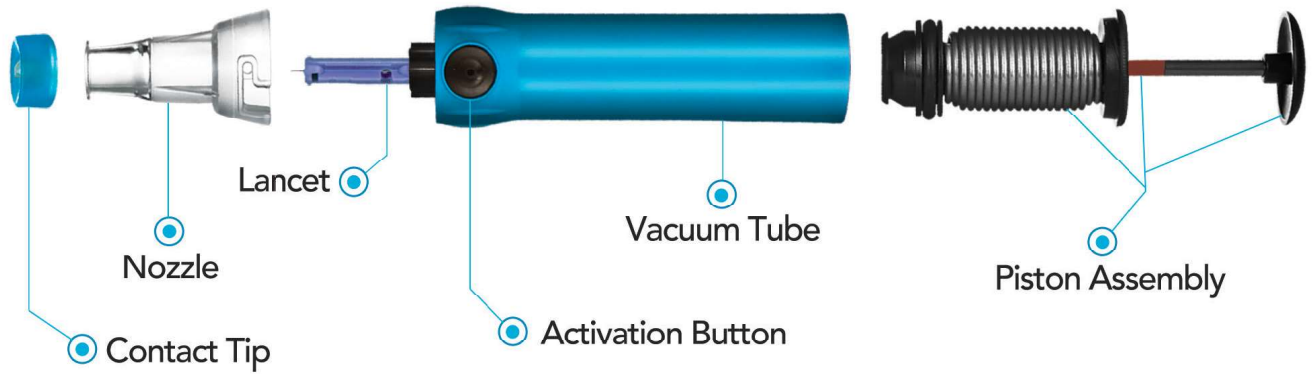

## About Genteel

Contact Tips	<ul style="list-style-type: none"> <li>• provides precise and customizable lancing depth</li> <li>• adjustable lancing depths for different parts of the body</li> </ul>
Vacuum	<ul style="list-style-type: none"> <li>• removes the need for re-pokes or squeezing, allows fingers to heal</li> <li>• vacuum makes getting blood from any body location convenient and easy</li> </ul>
Activation Button	<ul style="list-style-type: none"> <li>• allows the user to keep vacuum activated as long as needed, bringing more blood to the surface</li> </ul>

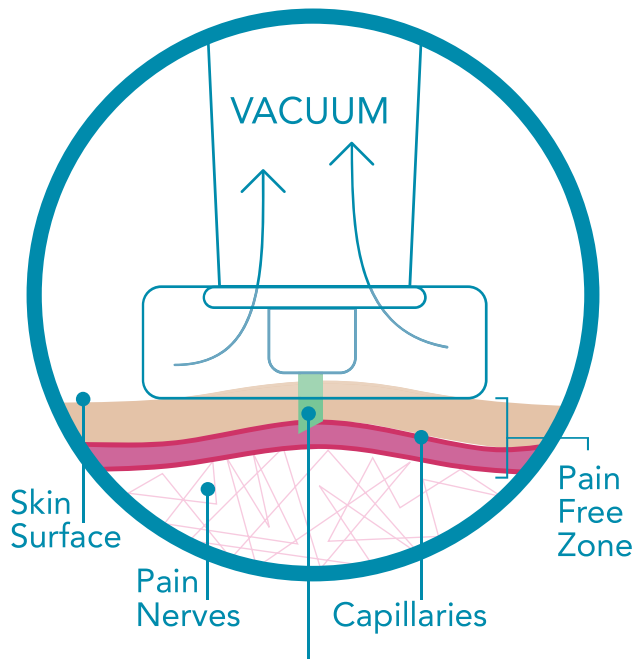

Lancing reaches the blood capillaries, but never the deeper pain nerves











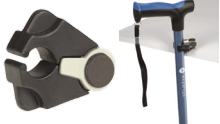





This product is covered by the following patents. Additional patents may be issued or pending: US8,460,210; US8,460,211; US8,480,596; US8,485,990; US8,485,991; US8,657,763; US9,770,201 B2; EP2525714; CA2792659

# Daily Living Aids

# Daily Living Aids

HMS Medical stocks a range of products to assist with making every day activities easier.



<p><b>7051003 Walking Cane Foldable</b></p> 	<p><b>70510420 Walking Cane Black</b></p> 
<p><b>70510150 Walking Cane Holder</b></p> 	<p><b>70610050 Pill Splitter</b></p> 
<p><b>70610350 Pill Organiser</b></p> 	<p><b>70610070 Pill Crusher</b></p> 
<p><b>70610360 Pill Processor</b></p> 	<p><b>90610050 Smart Pill Box</b></p> 
<p><b>70610060 Pill Pusher</b></p> 	<p><b>70610080 Pill Box</b></p> 
<p><b>7610010 Bandage wrap - Wrist</b></p> 	<p><b>70610020 Bandage wrap - Ankle</b></p> 
<p><b>70610030 Bandage wrap - Knee</b></p> 	<p><b>70610040 Bandage wrap - Elbow</b></p> 
<p><b>70610260 Bandage wrap - Tennis Elbow</b></p> 	<p><b>70110080 Nail Scissors - XL</b></p> 
<p><b>70110570 Foot rasp with file</b></p> 	<p><b>70110130 Lotion applicator</b></p> 
<p><b>70110380 Lotion applicator sponges</b></p> 	<p><b>70110600 Nail clipper</b></p> 
<p><b>70110580 Nail file</b></p> 	<p><b>70110140 Nail brush</b></p> 
<p><b>70110150 Nail file - steady</b></p> 	<p><b>70110070 Tube squeezer</b></p> 

<p><b>70610270 Arm sling</b></p>  	
<p><b>70110290 Urinal brush</b></p> 	<p><b>70410060 Playing cards</b></p> 
<p><b>70410070 Playing cards holder</b></p> 	<p><b>70110220 Shower mat</b></p>  
	<p><b>70110180 Bath rail - 30cm / 11.8in</b></p> 
<p><b>70410240 Foam grips - 8 pieces</b></p> 	
<p><b>70210390 Antislip bottle opener</b></p> 	<p><b>70210380 Antislip jar opener</b></p> 
<p><b>70410250 Pengrip - triangular</b></p>  	<p><b>70410030 Magnifier - pocket</b></p> 
	<p><b>70210280 Plate rim</b></p>  
	<p><b>70210330 Scissors - multi blade</b></p> 
<p><b>70210340 Multi purpose scissors</b></p> 	<p><b>70210110 Can opener</b></p>  
<p><b>60110040 Mobile Grab Rail</b></p> 	<p><b>60110050 Sower Stool Square</b></p> 
<p><b>60110010 Shower Arm Sleeve</b></p> 	<p><b>60110020 Shower Sleeve Leg</b></p> 
<p><b>80110140 Inflatable hair washbasin</b></p> 	<p><b>60110030 Urinal Unisex</b></p> 
<p><b>70110260 Urinal - Mens</b></p> 	<p><b>70110270 Urinal - Womens</b></p> 

**T: 1300 106 003**  
**Dir: 07 3117 9539**  
**F: 07 3036 6625**

**E: [sales@hmsmedical.com.au](mailto:sales@hmsmedical.com.au)**

**[www.hmsmedical.com.au](http://www.hmsmedical.com.au)**



**May 2024**